

CUSTOM METAL FABRICATION

Custom flashing, metal roofing, wall cladding systems, architectural panels, bending, rollforming, shearing, sheeting, and more.

Architectural Panels

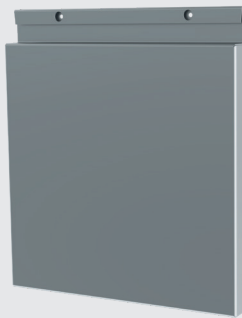

Aluminaire

- 2mm aluminum
- Pre-finished or post-finished by powder coating
- Soffit/wall applications, sized to suit
- Concealed fastening
- Noncombustible construction



Silhouette

- Aluminum, stainless steel, and other materials
- Perforations create patterns or full scenes
- Profiles are customizable to suit application



StrataClad*

- Light gauge steel with foam fill for rigidity
- Wide range of prefinished colours and prints
- Soffit/wall applications, sized to suit
- Concealed fastening

Substructure Components*

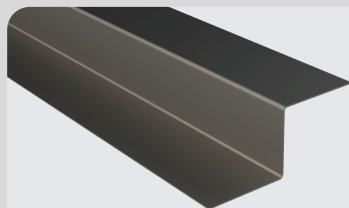

Z-Bar

- Galvanized steel and aluminum
- Available in 14 gauge to 22 gauge
- Dimensions are customizable to suit application

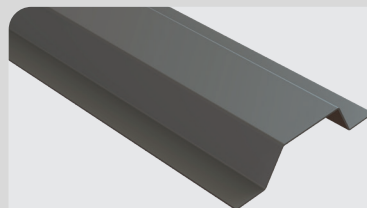

Hat Bar

- Galvanized steel and aluminum
- Available in 14 gauge to 22 gauge
- Dimensions are customizable to suit application

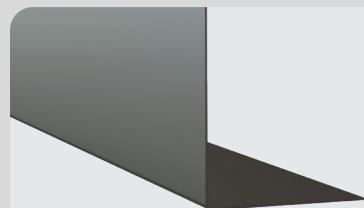

L-Angle

- Galvanized steel and aluminum
- Available in 14 gauge to 22 gauge
- Dimensions are customizable to suit application

Cladding

- Light gauge prefinished steel
 - Soffit/wall applications, vertical or horizontal
 - Concealed fastening

ShadowClad

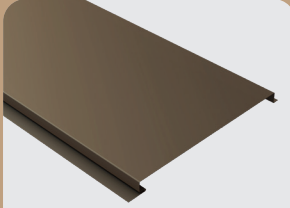

Prime

- 6", 8", or 12" Coverage, 1" Depth, Reveal up to 1", Length up to 20'
 - Options include Venting, and V ribs

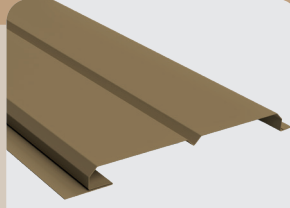

Tongue and Groove

- 8" or 10" Coverage, 1" Depth, Length up to 20'
 - Each panel comprises 2 planks with chamfer edges

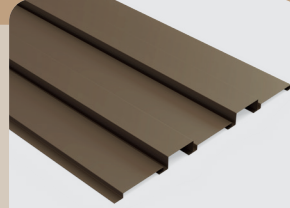

Custom

- Custom Coverages and Depths available, Length up to 20'
 - Contact Lenmak Sales Team for size options and limitations

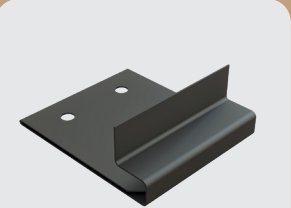

Slip Clip

- Specific to ShadowClad
 - Soffit/wall, vertical/horizontal
 - Allows panels to move with temperature

OmniClad

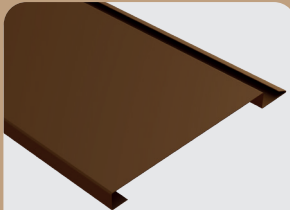

OmniClad

- 10.375, 8.375, and 6" Coverage, 0.75" Depth, Length up to 26'
 - Available splice or reveal plates for end joints

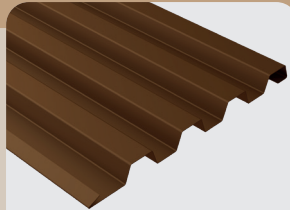

OmniClad SlimRib

- 10" Coverage, 0.75" Depth, Length up to 26'

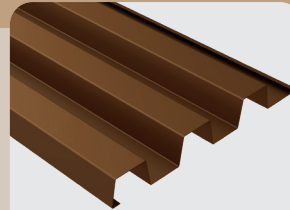

OmniClad Ribbed

- 12" Coverage, 0.75" Depth, Length up to 26' long
 - 4 unique profiles the compliment each other

InterClad

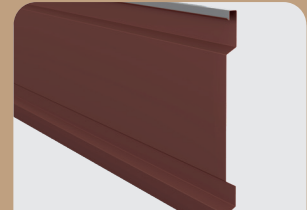

Prime

- 16.875" Coverage, 1" Depth, Length up to 20'
 - Options of venting, and ribs
 - Clips available

InterClad



Duo XL

- 17.75" Coverage, 1" Depth, Length up to 20'
 - Clips available

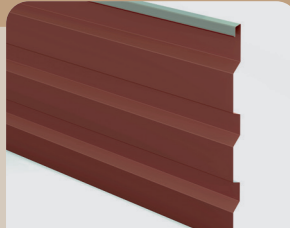

Trio

- 16.5" Coverage, 1" Depth, Length up to 20'
 - Clips available

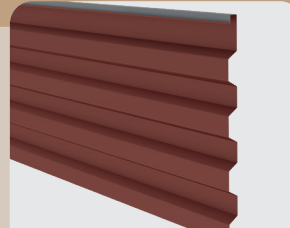

Quattro

- 16.125" Coverage, 1" Depth, Length up to 20'
 - Clips available

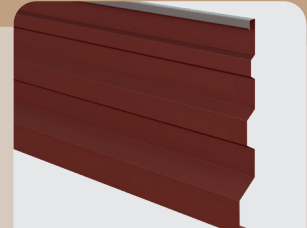

Custom

- Achieve a custom look for your project
 - Clips available

Accessories

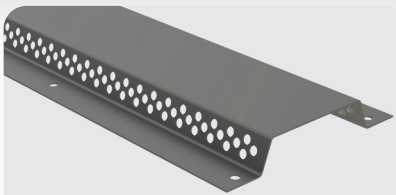

Vented Slotted Hat Channel

- Galvanized steel and aluminum
 - Available in 14 gauge to 22 gauge
 - Dimensions are customizable to suit app.
 - Venting and slotted sizing and spacing are customizable

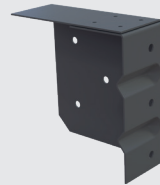

Thermal Max Clip

- Compatible with a variety of wall build-up conditions and cladding types
 - The thermal isolator tape helps to reduce thermal bridging through the wall assembly and prevent air leakage



Soffit

- Light gauge prefinished steel and aluminum
 - Concealed fastening
 - 12" coverage
 - Several rib options available

Roofing

- Light gauge prefinished steel
- Wide range of colours and prints
- Concealed fastening

Styles of panels

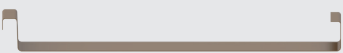

Mechanical Lock

- 1", 1.5", or 2" seam, 2 widths per, 3 rib patterns
- Concealed fastening with clips (req. seamer)
- Full roof decks or open purlins; low-slope (some seam sizes)



Snap Lock

- 1" or 1.5" seam, 2 widths per, 3 rib patterns
- Concealed fastening with clips, pressure interlock
- Full decking only, ideal for long runs



Nail Strip

- 1" or 1.5" seam, 2 widths per, 3 rib patterns
- Concealed fastening integrated into panels, pressure interlock
- Full decking only, shorter runs/slope over 3/12

Options



Flat

- Flat face available in 22 gauge and select sizes of 24 gauge

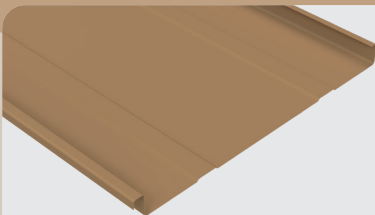

Pencil Rib

- Two parallel ribs add character
- Available in 26 gauge, 24 gauge and 22 gauge

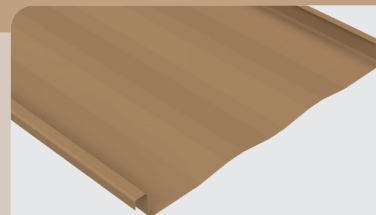

Striation

- Stiffen belly of the panel
- Available in 26 gauge, 24 gauge, and 22 gauge

Trim

- Light gauge prefinished steel and aluminum
- Standard length 10' with custom lengths available

Window Battens

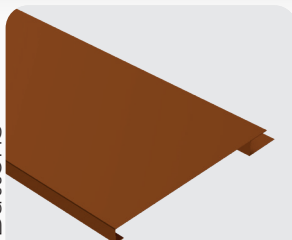

- Multiple depths and face sizes

Fascia

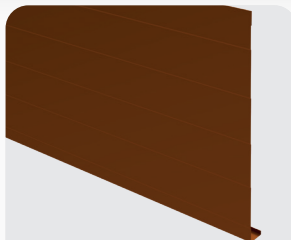

- Multiple depths and face sizes
- Multiple rib options

J Channel



- Custom pockets and face sizes

Drip Cap



- Colour wrapped profiles

2-piece Transition



- Install Transition cap after panel
- Base in depths of 0.75" to 2"
- Quickest Panel Joint/Transition option to install

2-piece Outside Corner



- Install finishing cap after panel
- Base in depths from 0.75" to 2"
- Corner cap min. face size is 2"

2-piece J Channel



- Install finishing cap after panel
- Base in depths from 0.75" to 2"
- Custom size of face of cap

2-piece Inside Corner



- Install finishing cap after panel
- Base in depths from 0.75" to 2"
- Corner cap min. face size is 2"

*Product contains a combustible element. Consult building code and design requirements prior to purchase or use.



Available colours and accessories

For colour availability, please refer to Lenmak.com. Lenmak stocks coloured screws and accessories to complement our product offering.



Custom service

Custom service includes cut-to-length panels, panel corner notching, and panel venting. Our Computer Numerally Controlled bending cell can handle pieces of metal up to 26 feet long.



Curtain Wall

- Galvanized steel or anodized aluminum with bonded foam insulation (R4.3/in)
- Air and vapour tight, ready for installation

Envatherm*

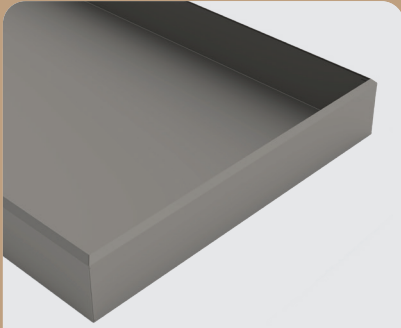

Inner Flange

- 45° angled gum-lip at perimeter, no fastening flange

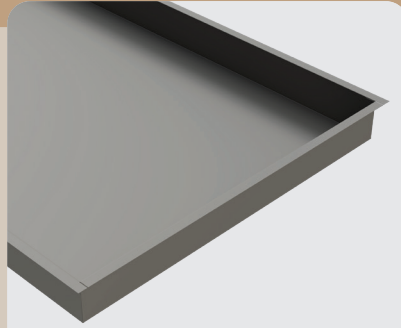

Square Flange

- Fastening flange at perimeter with available pre-punched holes



Tapered / Mitred Panel

- Empty panels without foam insulation
- Inner, Square, Box, and No flange configurations available

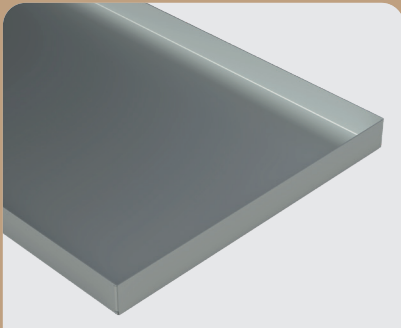

No Flange

- No fastening flange

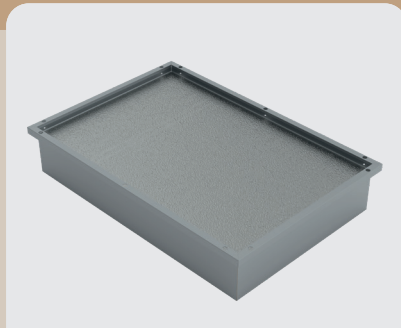

Box Style

- Fastening flange with customizable integrated glazing adaptor at perimeter



Accessories

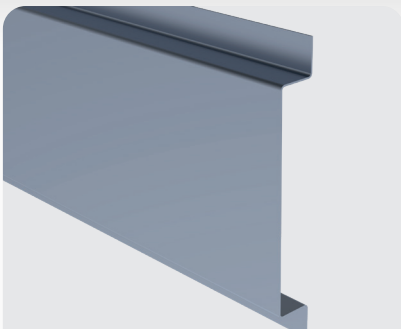

Anodized Flashing

- Custom flashing made to match anodized backpans

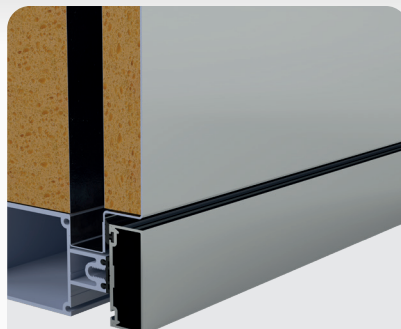

Spandrel Therm

- Aluminum spandrel panel with bonded foam insulation (R4.3 per inch)
- Air- and Vapour-tight, installation-ready
- Fastening flange at perimeter with available pre-punched holes

Assembly

- Light gauge steel with foam fill for rigidity
- Wide range of prefinished colours and prints
- Soffit/wall applications, sized to suit
- Concealed fastening

*Product contains a combustible element. Consult building code and design requirements prior to purchase or use.

OFFICE

10404 – 176 Street NW, Edmonton,
Alberta, Canada
T5S 1L3

CONTACT

Phone : (780) 451-5482
E-mail : orderdesk@lenmak.com
Website : www.lenmak.com

